



中山市川狼五金制品厂

ZHONG SHAN CHUAN LANG LIGHTING CO., LTD

型号: 模组投光灯-1000W

外观图



线条图

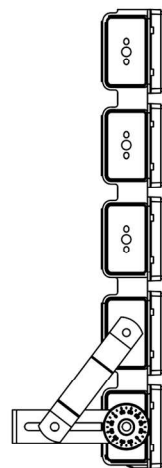
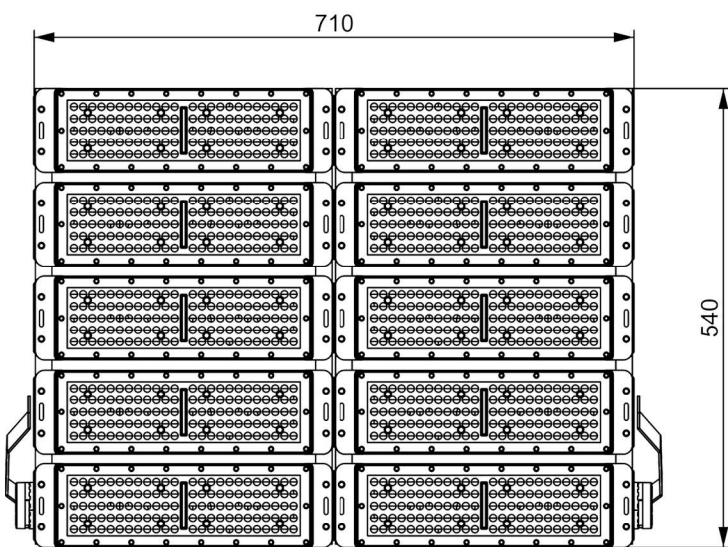

主视图
外形尺寸: W710mm * L540mm * H185mm

左视图

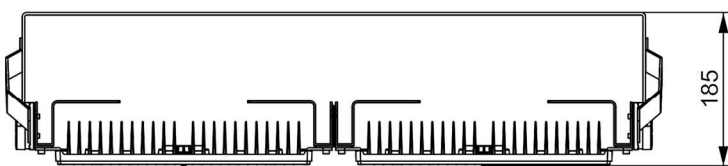

俯视图

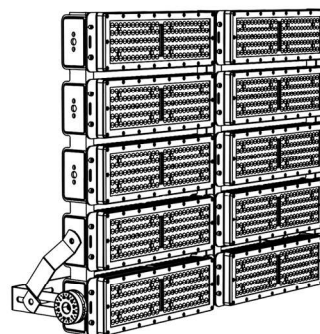

透视图

灯板-透镜

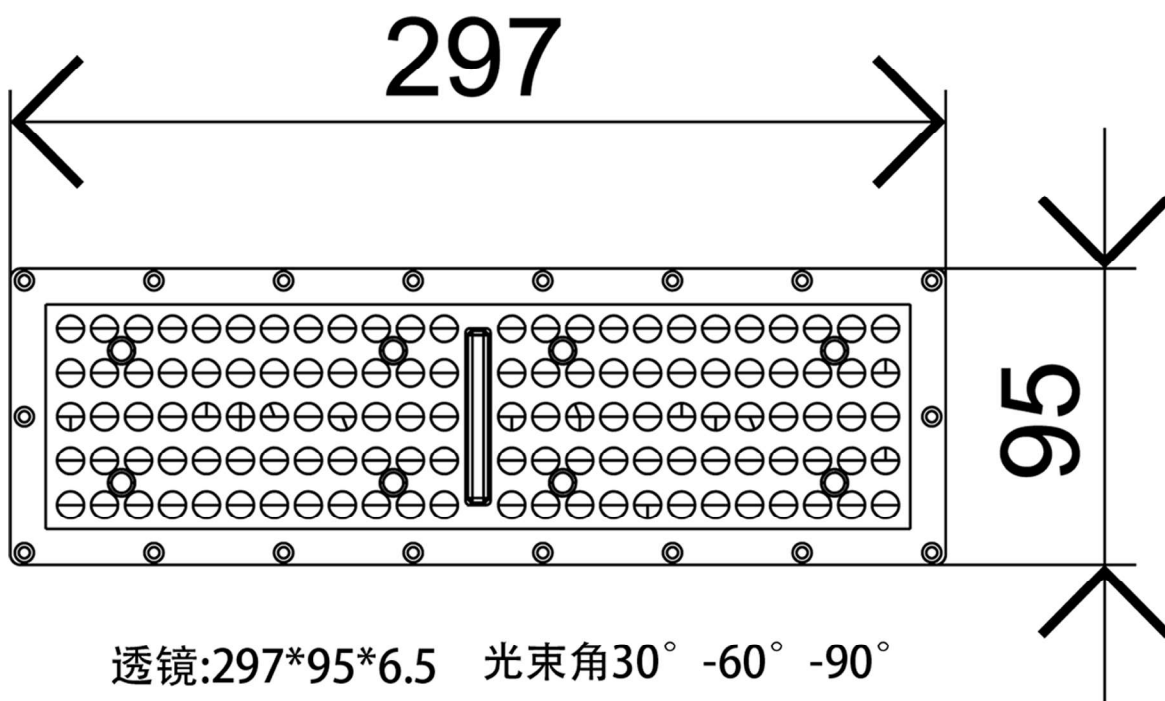
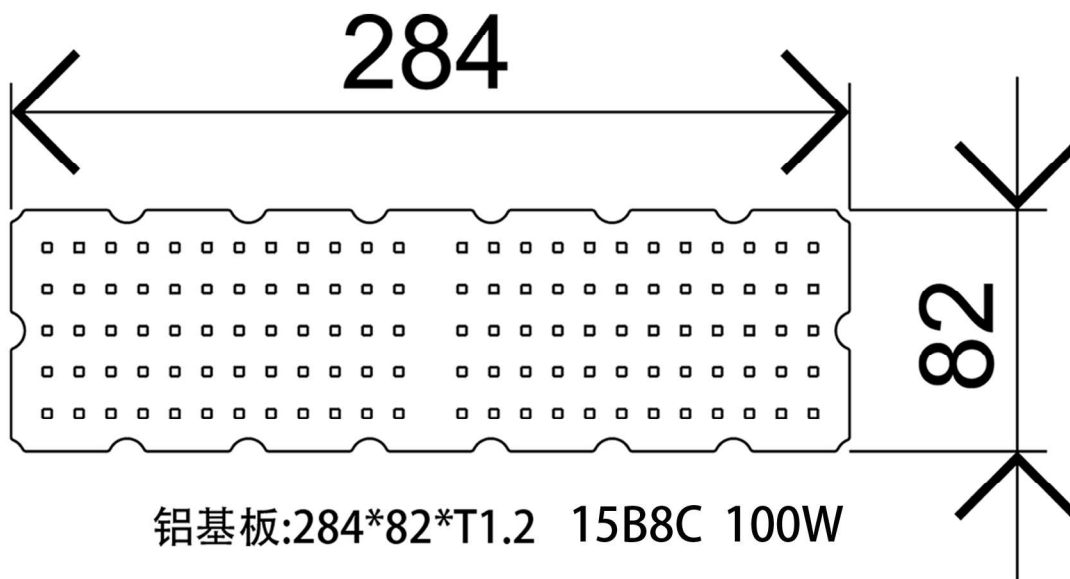

灯体尺寸孔位

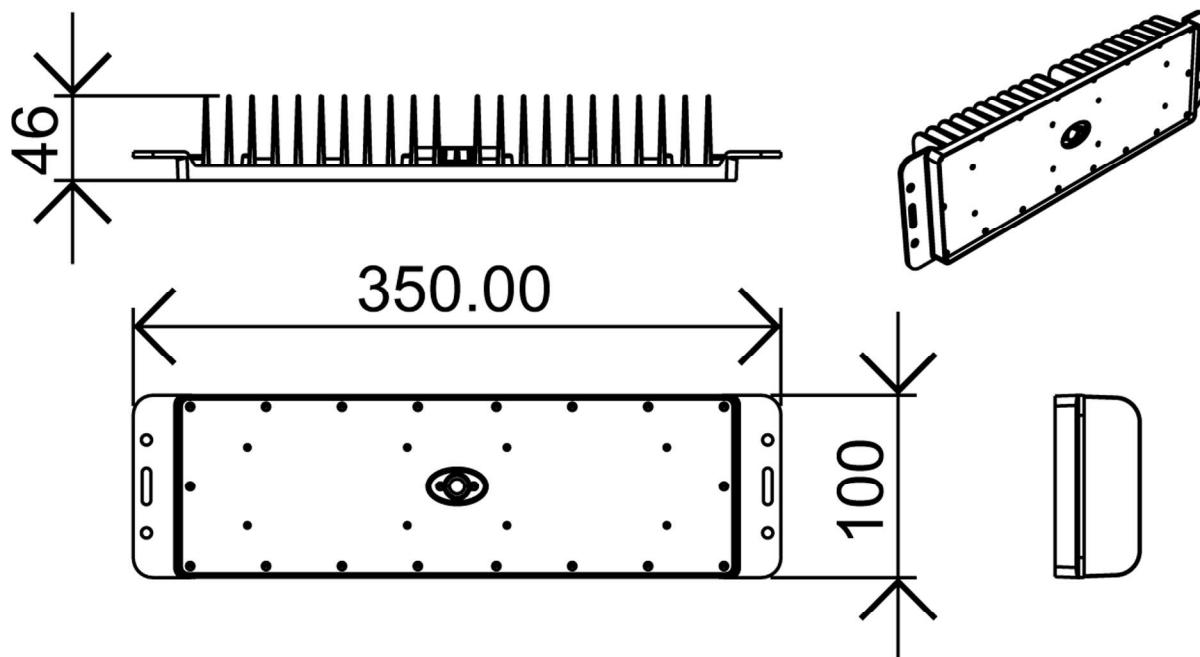

铝合金灯体 W350mm*L100mm*H46mm 重量0.9KG

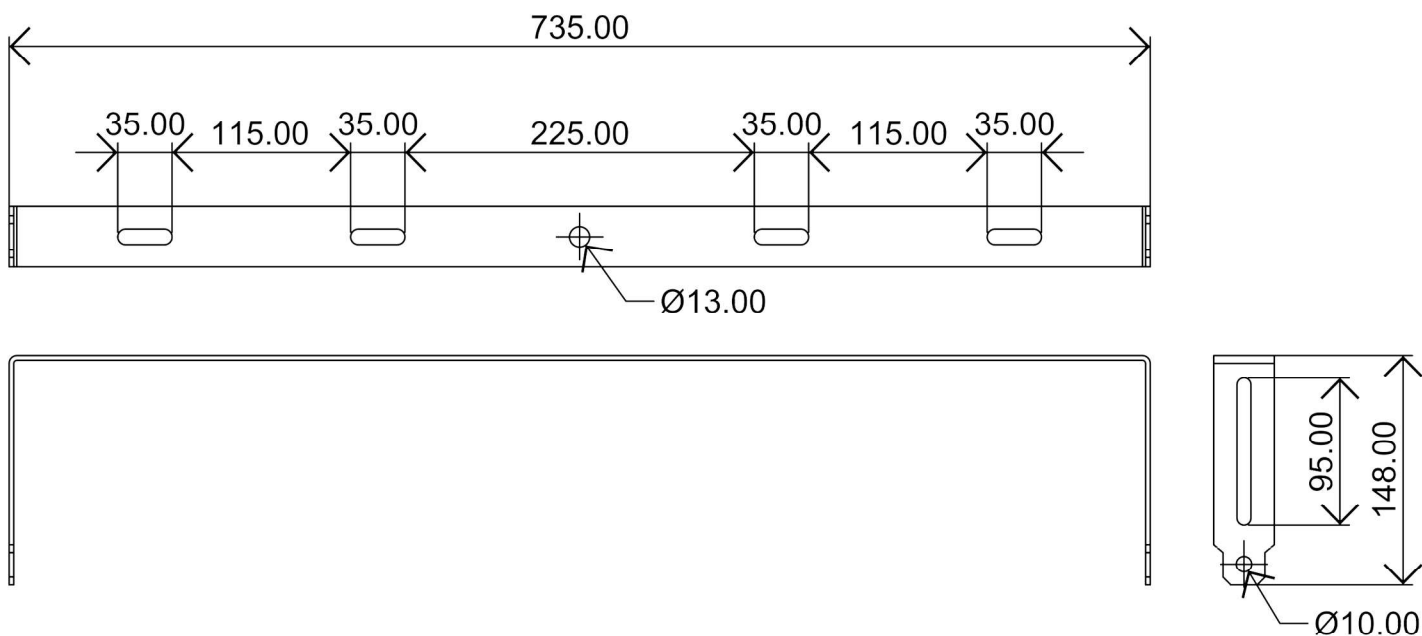

支架 W735mm*L148mm*H50mm 重量0.83KG

产品拆解图

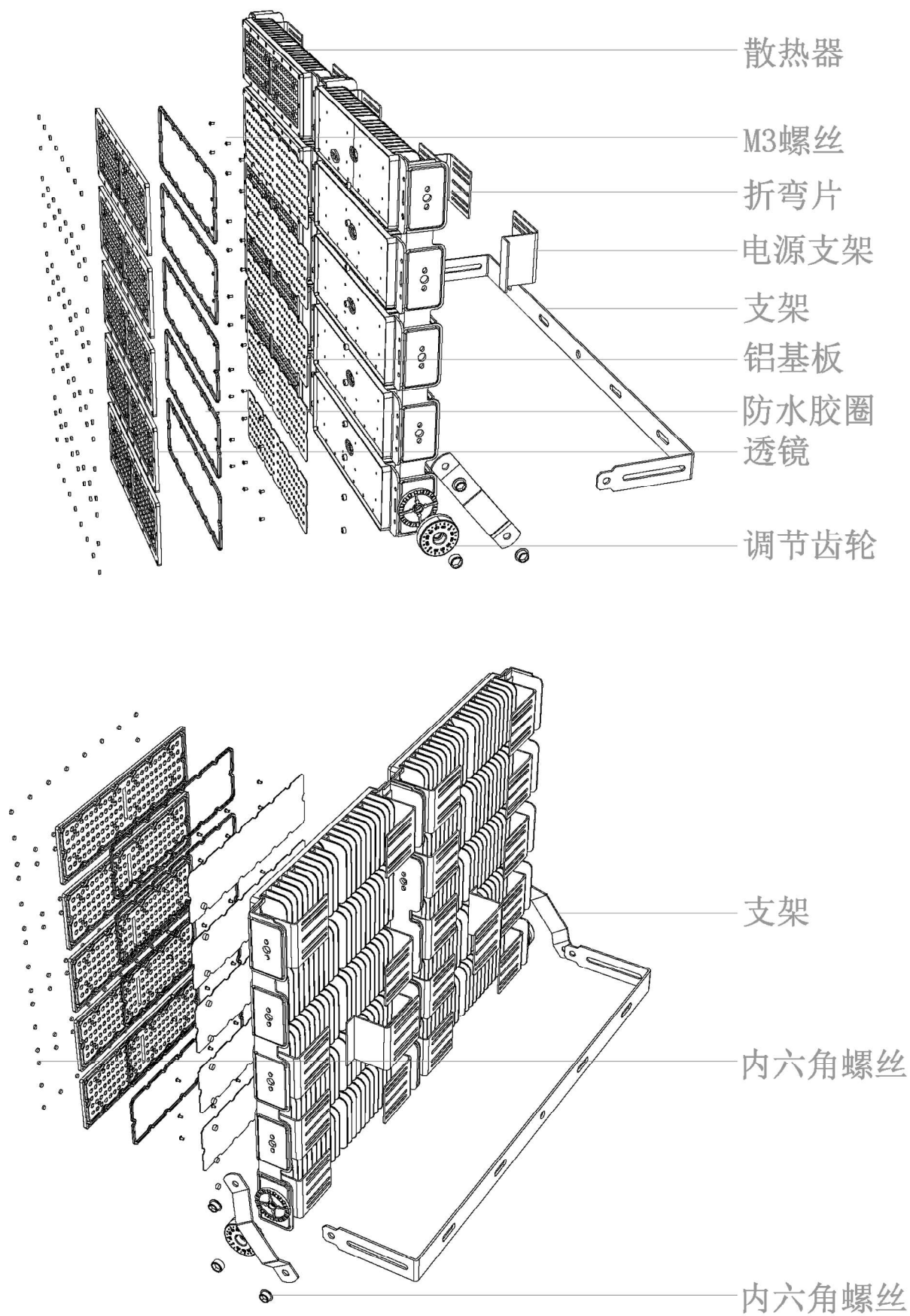

包装尺寸

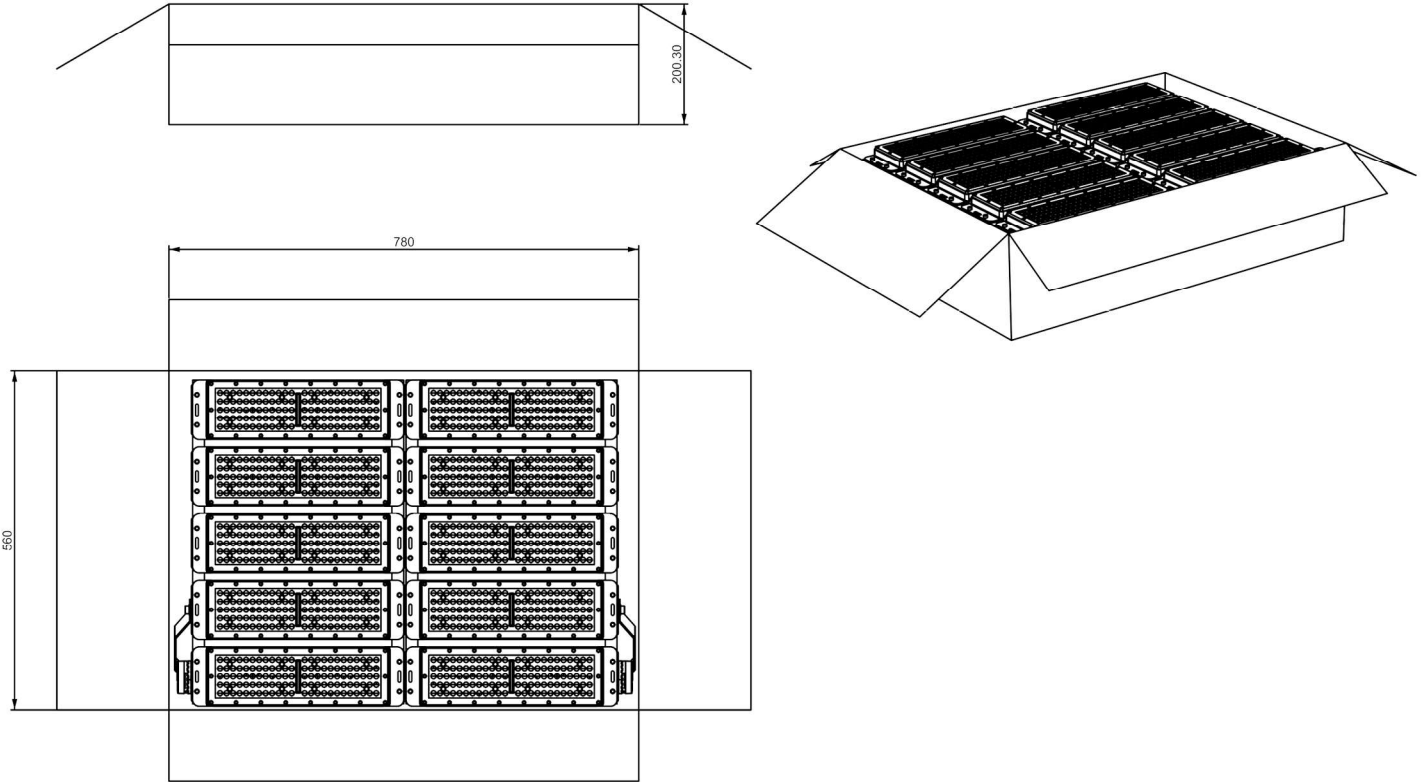

外箱尺寸：780mm*560mm*H200mm

包装总重量：17KG